

R30120G2



Pb Free Plating Product

30 Ampere, 1200Volt SwitchMode Single Fast Recovery Epitaxial Diode

APPLICATION

- g Freewheeling, Snubber, Clamp
- g Inversion Welder
- g PFC
- g Plating Power Supply
- g Ultrasonic Cleaner and Welder
- g Converter & Chopper
- g UPS

PRODUCT FEATURE

- g Ultrafast Recovery Time
- g Soft Recovery Characteristics
- g Low Recovery Loss
- g Low Forward Voltage
- g High Surge Current Capability
- g Low Leakage Current

TO-247-2L

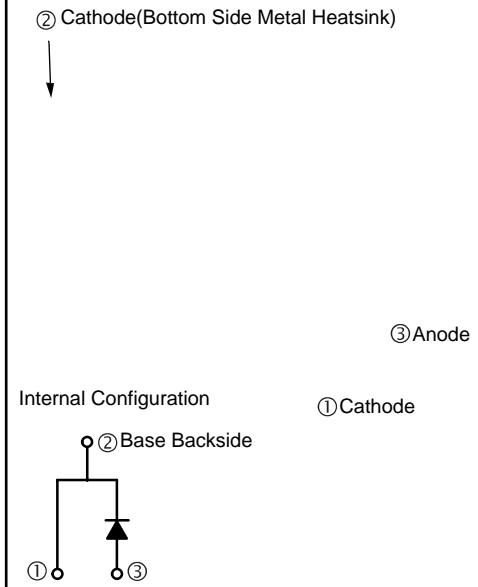

GENERAL DESCRIPTION

R30120G2 using the latest FRED FAB process(planar passivation pellet) with ultrafast and soft recovery characteristics.

ABSOLUTE MAXIMUM RATINGS

$T_C=25^{\circ}\text{C}$ unless otherwise specified

Symbol	Parameter	Test Conditions	Values	Unit
V_R	Maximum D.C. Reverse Voltage		1200	V
V_{RRM}	Maximum Repetitive Reverse Voltage		1200	V
$I_{F(AV)}$	Average Forward Current	$T_C=110^{\circ}\text{C}$	30	A
$I_{F(RMS)}$	RMS Forward Current	$T_C=110^{\circ}\text{C}$	42	A
I_{FSM}	Non-Repetitive Surge Forward Current	$T_J=45^{\circ}\text{C}$, $t=10\text{ms}$, 50Hz, Sine	300	A
P_D	Power Dissipation		115	W
T_J	Junction Temperature		-40 to +150	$^{\circ}\text{C}$
T_{STG}	Storage Temperature Range		-40 to +150	$^{\circ}\text{C}$
Torque	Module-to-Sink	Recommended ÄM3 Ä	1.1	N·m
$R_{\theta\text{-JC}}$	Thermal Resistance	Junction-to-Case	1.1	$^{\circ}\text{C/W}$
Weight			7.0	g

ELECTRICAL CHARACTERISTICS

$T_C=25^{\circ}\text{C}$ unless otherwise specified

Symbol	Parameter	Test Conditions	Min.	Typ.	Max.	Unit
I_{RM}	Reverse Leakage Current	$V_R=1200\text{V}$	--	--	100	μA
		$V_R=1200\text{V}$, $T_J=125^{\circ}\text{C}$	--	--	1	mA
V_F	Forward Voltage	$I_F=30\text{A}$	--	2.15	2.5	V
		$I_F=30\text{A}$, $T_J=125^{\circ}\text{C}$	--	1.75	--	V
t_{rr}	Reverse Recovery Time	$I_F=1\text{A}$, $V_R=30\text{V}$, $di_F/dt=-2 \text{ } \text{\$/ V}$	--	30	--	ns
t_{rr}	Reverse Recovery Time	$V_R=600\text{V}$, $I_F=30\text{A}$	--	160	--	ns
I_{RRM}	Max. Reverse Recovery Current	$di_F/dt=-2 \text{ } \text{\$/ V}$, $T_J=25^{\circ}\text{C}$	--	5	--	A
t_{rr}	Reverse Recovery Time	$V_R=600\text{V}$, $I_F=30\text{A}$	--	300	--	ns
I_{RRM}	Max. Reverse Recovery Current	$di_F/dt=-2 \text{ } \text{\$/ V}$, $T_J=725^{\circ}\text{C}$	--	11	--	A

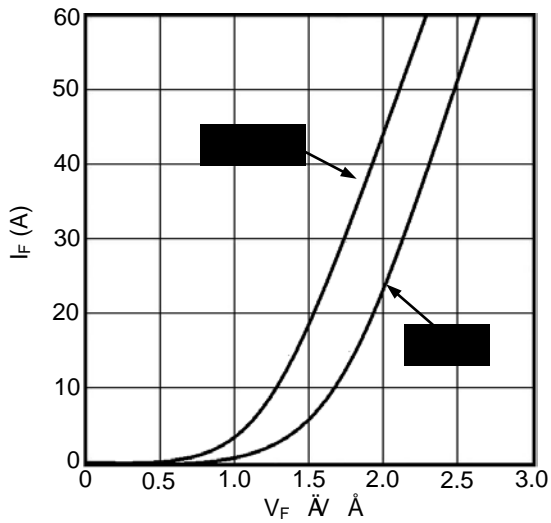

Fig1. Forward Voltage Drop vs Forward Current

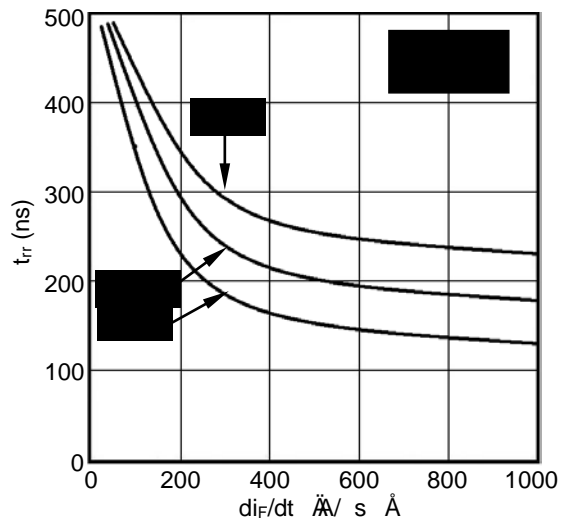

Fig2. Reverse Recovery Time vs di_F/dt

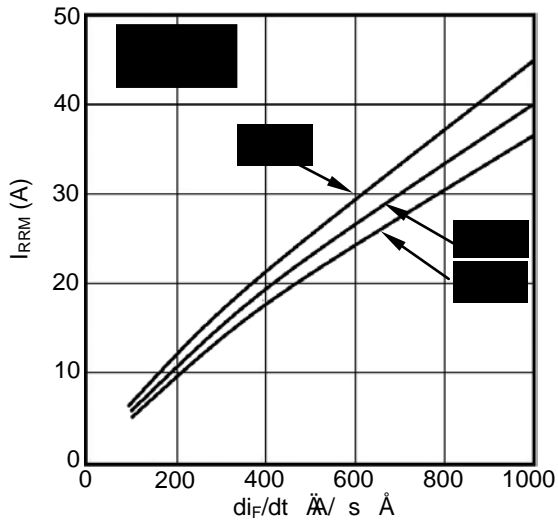

Fig3. Reverse Recovery Current vs di_F/dt

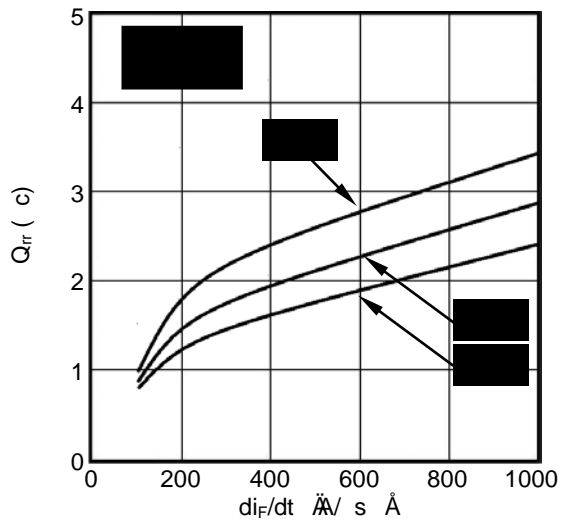

Fig4. Reverse Recovery Charge vs di_F/dt

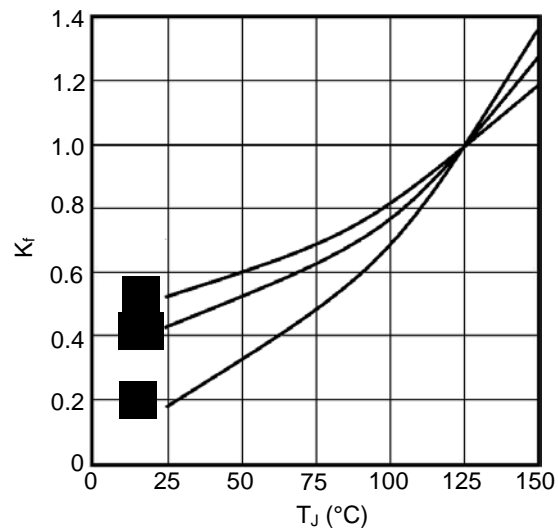

Fig5. Dynamic Parameters vs Junction Temperature

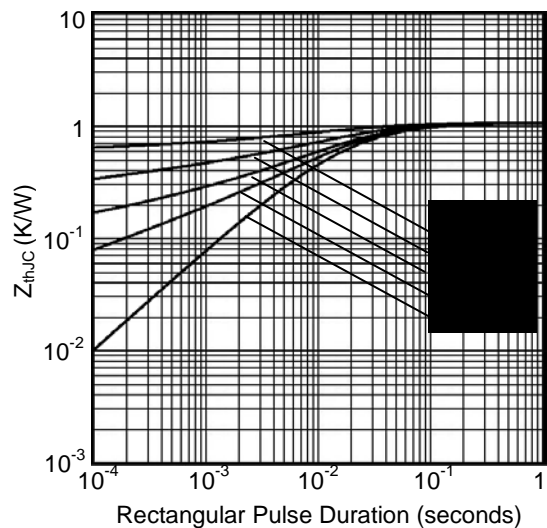

Fig6. Transient Thermal Impedance

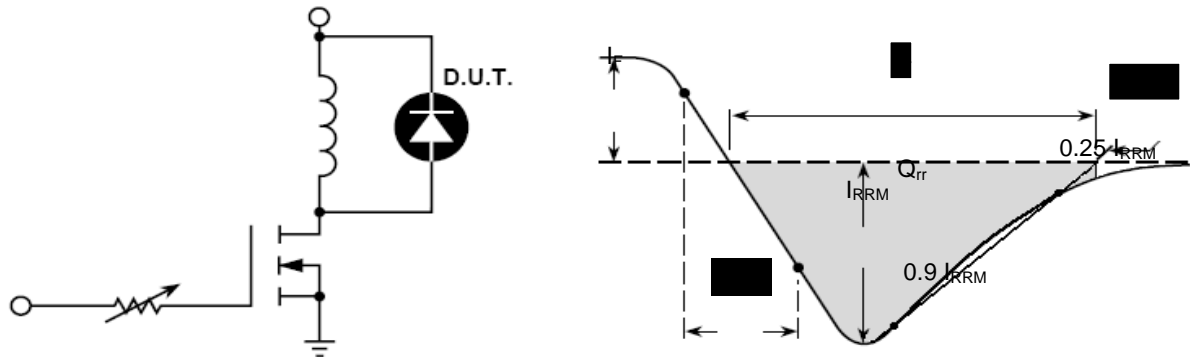
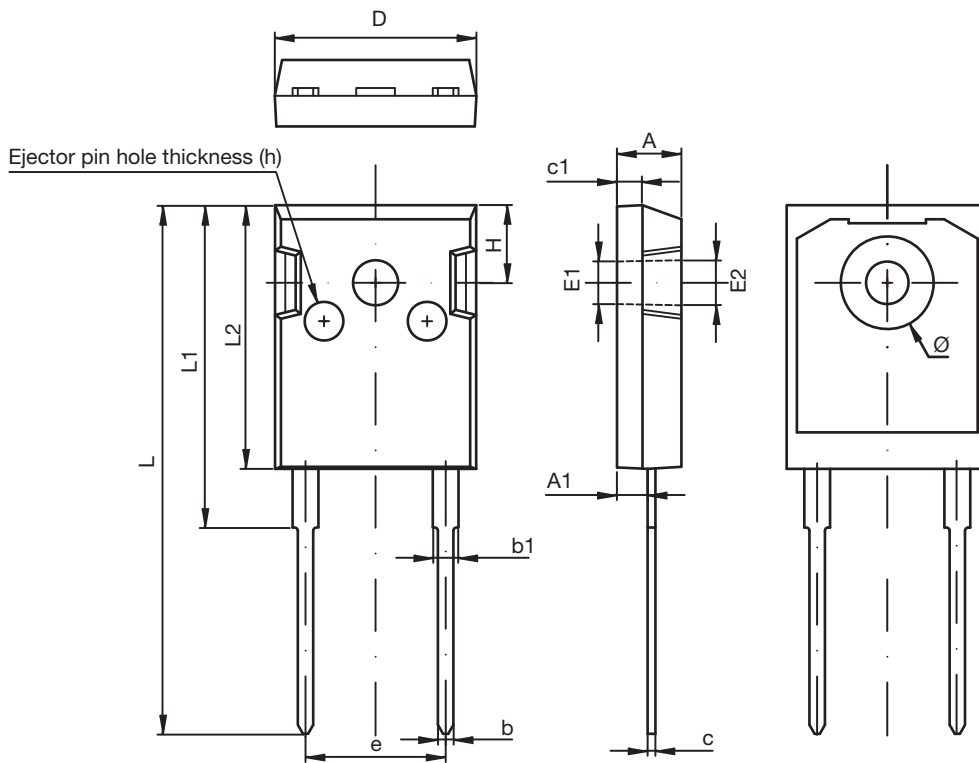

Fig7. Diode Reverse Recovery Test Circuit and Waveform



TO-247-2L DIMENSIONS

SYMBOL	DIMENSIONS IN MILLIMETERS		DIMENSIONS IN INCHES	
	MIN.	MAX.	MIN.	MAX.
A	4.850	5.150	0.191	0.200
A1	2.200	2.600	0.087	0.102
b	1.000	1.400	0.039	0.055
b1	1.800	2.200	0.071	0.087
c	0.500	0.700	0.020	0.028
c1	1.900	2.100	0.075	0.083
D	15.450	15.750	0.608	0.620
E1	3.500 Ref.		0.138 Ref.	
E2	3.600 Ref.		0.142 Ref.	
L	40.900	41.300	1.610	1.626
L1	24.800	25.100	0.976	0.988
L2	20.300	20.600	0.799	0.811
Ø	7.100	7.300	0.280	0.287
e	10.900 Typ.		0.429 Typ.	
H	5.980 Typ.		0.235 Typ.	
h	0.000	0.300	0.000	0.012